

A SELECTION FROM THE VAST RANGE OF

# Clarke<sup>®</sup>

## QUALITY PRODUCTS

### **AIR COMPRESSORS**

From DIY to industrial. Plus air tools, spray guns and accessories.

### **GENERATORS**

Prime duty or emergency standby for business, home and leisure.

### **POWER WASHERS**

Hot and cold, electric and engine driven - we have what you need.

### **WELDERS**

Mig, Arc, Tip and Spot. From DIY to auto/industrial.

### **METALWORKING**

Drills, grinders and saws for DIY and professional use.

### **WOODWORKING**

Saws, sanders, lathes, mortisers and dust extraction.

### **HYDRAULICS**

Cranes, body repair kits, transmission jacks for all types of workshop use.

### **WATER PUMPS**

Submersible, electric and engine driven for DIY, agriculture and industry.

### **POWER TOOLS**

Angle grinders, cordless drill sets, saws and sanders.

### **STARTER/CHARGERS**

All sizes for car & commercial use.



**Clarke** INTERNATIONAL

For spare parts and servicing, please contact your nearest dealer, or Clarke International on

**020 - 8988 - 7400**

e-mail: [Parts@clarkeinternational.com](mailto:Parts@clarkeinternational.com) e-mail: [Service@clarkeinternational.com](mailto:Service@clarkeinternational.com)

# Clarke<sup>™</sup>

## air

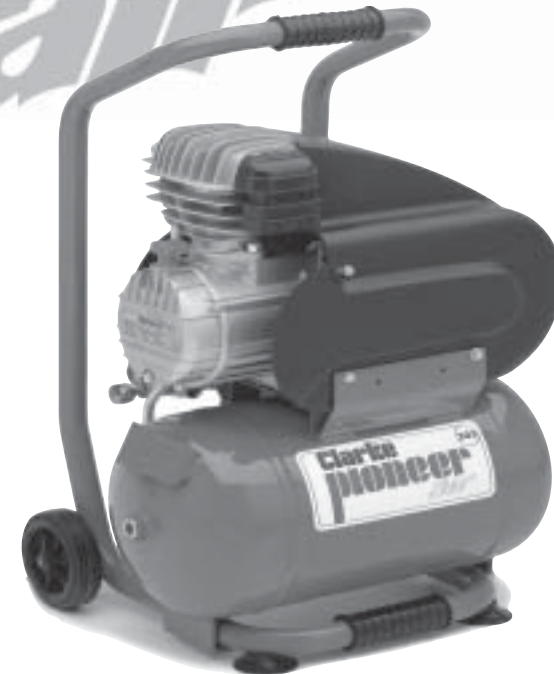

## PIONEER 205

# OPERATING & MAINTENANCE INSTRUCTIONS



# Clarke<sup>®</sup>

SPARES AND SERVICING

## Clarke<sup>®</sup> INTERNATIONAL

Please contact your nearest dealer, or  
CLARKE International, on one of the following numbers.

**PARTS & SERVICE TEL: 020 8988 7400**

**PARTS & SERVICE FAX: 020 8558 3622**

or e-mail as follows:

**PARTS: [Parts@clarkeinternational.com](mailto:Parts@clarkeinternational.com)**

**SERVICE: [Service@clarkeinternational.com](mailto:Service@clarkeinternational.com)**

# Clarke<sup>®</sup>

SPARES AND SERVICING

## Clarke<sup>®</sup> INTERNATIONAL

Please contact your nearest dealer, or  
CLARKE International, on one of the following numbers.

**PARTS & SERVICE TEL: 020 8988 7400**

**PARTS & SERVICE FAX: 020 8558 3622**

or e-mail as follows:

**PARTS: [Parts@clarkeinternational.com](mailto:Parts@clarkeinternational.com)**

**SERVICE: [Service@clarkeinternational.com](mailto:Service@clarkeinternational.com)**

## PARTS LIST

No.	Description	Qty	Part No.	No.	Description	Qty	Part No. *
1	Head Bolt	4	FN014002021	36	Cover	1	FN116117015
2	After Cooler	1	FN116117020	37	Reset Button	1	FN008040000
3	Cylinder Head	1	FN016055040	38	Washer	1	FN010072000
4	Air Filter Assy	1	FN317050000	39	Filter Element	1	FN116055043
5	Head Gasket	1	FN116117002	-	Gasket Set Compl.	1	FN216HN0001
6	Valve Block	1	FN116022100	50	Reservoir	1	N164A51000V
7	Bolt	2	FN014013021	51	Retaining Ring	2	FN015018000
8	O-Ring	1	FN010102000	52	Wheel	2	FN020006000
9	Gasket	1	FN116022010	53	Anti-Vibration Pads	2	FN116011006
10	Bolt	2	FN014011064	54	Bolt	2	FN014006022
11	Cylinder	1	FN116001004	55	Drain Valve	1	FN022022000
12	Sealing Ring	1	FN010114000	56	Screw	4	FN014013042
13	Piston Ring Set	1	FN216022002	57	Power Cable	1	FN101GA0200
14	Piston 47	1	FN116022004	58	Valve	1	FN347022000
15	Gudgeon Pin	1	FN116022040	59	Press. Gauge - Res.	1	FN330004000
16	Circlip	2	FN015001000	60	Pressure Gauge - line	1	FN330006000
17	Piston Complete	1	FN416022004	61	Washer	2	FN014005037
18	Con-Rod	1	FN116091021	65	Output Reg. Assy	1	FN319013000
19	Washer	1	FN014005006	66	Adapter	1	FN011017000
20	Capacitor	1	FN009200015	67	Pressure Reg. Assy	1	FN321053000
21	Bearing	1	FN033018000	68	Adapter	1	FN199110140
22	Shaft Assy	1	FN116032006	69	Connector	1	FN011248000
23	Gasket	1	FN116001025	70	Tube	1	FN101HN0010
24	Dipstick	1	FN012035000	71	Anti-Vibration Pad	4	FN199575000
25	End Housing	1	FN016032014	72	Valve	1	FN047113001
26	Screw	1	FN014013024	73	Spring	1	FN047113002
27	Screw	5	FN014006121	74	Valve Housing	1	FN010041000
28	Bolt	2	FN116011038	75	Valve Assy	1	FN347043000
29	Housing	1	FN116022051	76	Handle	2	FN116022015
30	Rotor	1	FN116032007	77	End Plug	2	FN011008000
31	Stator	1	FN416033604	78	Hose	1	FN046001000
32	Bearing	1	FN033005000	79	Elbow	1	FN011055000
33	End Housing	1	FN116011001	80	Tap Assy	1	FN322007000
34	Nut	2	FN014003002	81	Quick Release Coupl.	1	FN116011065
35	Fan	1	FN116001003				

Thank you for purchasing this Pioneer 205 Air Compressor which is fitted with a 9.5 litre air receiver.

Before attempting to operate the machine, please read this leaflet thoroughly and carefully follow the instructions given. In doing so you will ensure the safety of yourself and that of others around you, and you can also look forward to the compressor giving you long and satisfactory service.

## GUARANTEE

This product is guaranteed against faulty manufacture for a period of 12 months from the date of purchase. Please keep your receipt as proof of purchase. This guarantee is invalid if the product is found to have been abused or tampered with in any way, or not used for the purpose for which it was intended.

Faulty goods should be returned to their place of purchase, no product can be returned without prior permission. This guarantee does not effect your statutory rights.

## CONTENTS

	Page
Safety Precautions .....	4
Electrical Connections .....	5
Preparation for Use .....	6
Operation .....	6
Shutting Down .....	8
Maintenance .....	8
Fault Finding .....	10
Specifications .....	11
Accessories .....	11
Parts Lists and Diagrams .....	12 - 14
Parts and Service .....	2 & 15

## SAFETY PRECAUTIONS

### WARNING

*As with all machinery, there are certain hazards involved with their operation and use. Exercising respect and caution will considerably lessen the risk of personal injury. However, if normal safety precautions are overlooked, or ignored, personal injury to the operator, or damage to property may result. It is in your own interest to read and pay attention to the following rules:*

1. COMPRESSED AIR IS DANGEROUS, NEVER direct a jet of air at people or animals, and NEVER discharge compressed air against the skin.
2. DO NOT operate your compressor with any guards removed.
3. Electrical or mechanical repairs should only be carried out by a qualified engineer. If problems occur, contact your Clarke dealer.
4. Before carrying out any maintenance, ensure the pressure is expelled from the air receiver, and the machine is disconnected from the mains supply.
5. DO NOT leave pressure in the receiver overnight, or when transporting.
6. DO NOT adjust, or tamper with the safety valves. The maximum pressure is factory set, and clearly marked on the machine.
7. DO NOT operate in wet or damp conditions. Keep the machine dry at all times. Similarly, a clean atmosphere will ensure efficient operation. Do not use in dusty or otherwise dirty locations.
8. Some of the metal parts can become quite hot during operation. Take care not to touch these until the machine has cooled down.
9. Always adjust the pressure regulator to the recommended setting for the particular spray gun or tool being used.
10. When spraying inflammable materials e.g. cellulose paint, ensure that there is adequate ventilation and keep clear of any possible source of ignition.
11. Protect yourself. Think carefully about any potential hazards which may be created by using the air compressor and use the appropriate protection. e.g. Goggles will protect your eyes from flying particles. Face masks will protect you against paint spray and/or fumes.
12. Before spraying any material always consult paint manufacturers instructions for safety and usage.
13. Do not exert any strain on electrical cables and ensure that air hoses are not tangled or wrapped around machinery etc.
14. When disconnecting air hoses or other equipment from your compressor ensure that the air supply is turned off at the machine outlet and expel all pressurised air from within the machine and other equipment attached to it.
15. Make sure that children and animals are kept well away from the compressor and any equipment attached to it.
16. Always ensure that all individuals using the compressor have read and fully understand the Operating Instructions supplied.
17. Ensure that any equipment or tool used in conjunction with your compressor, has a safety working pressure exceeding that of the machine.

## COMPRESSOR

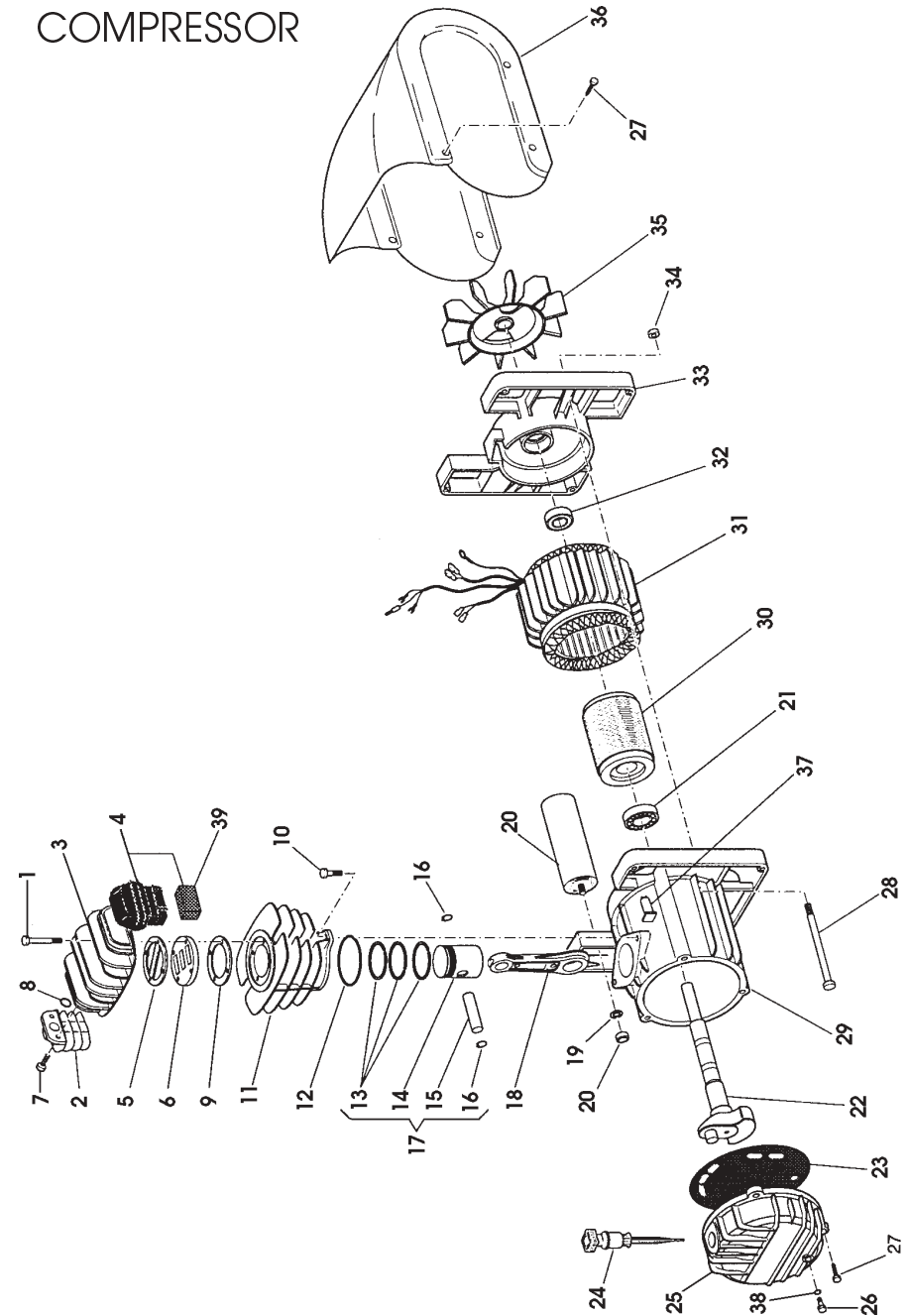

# PIONEER 205

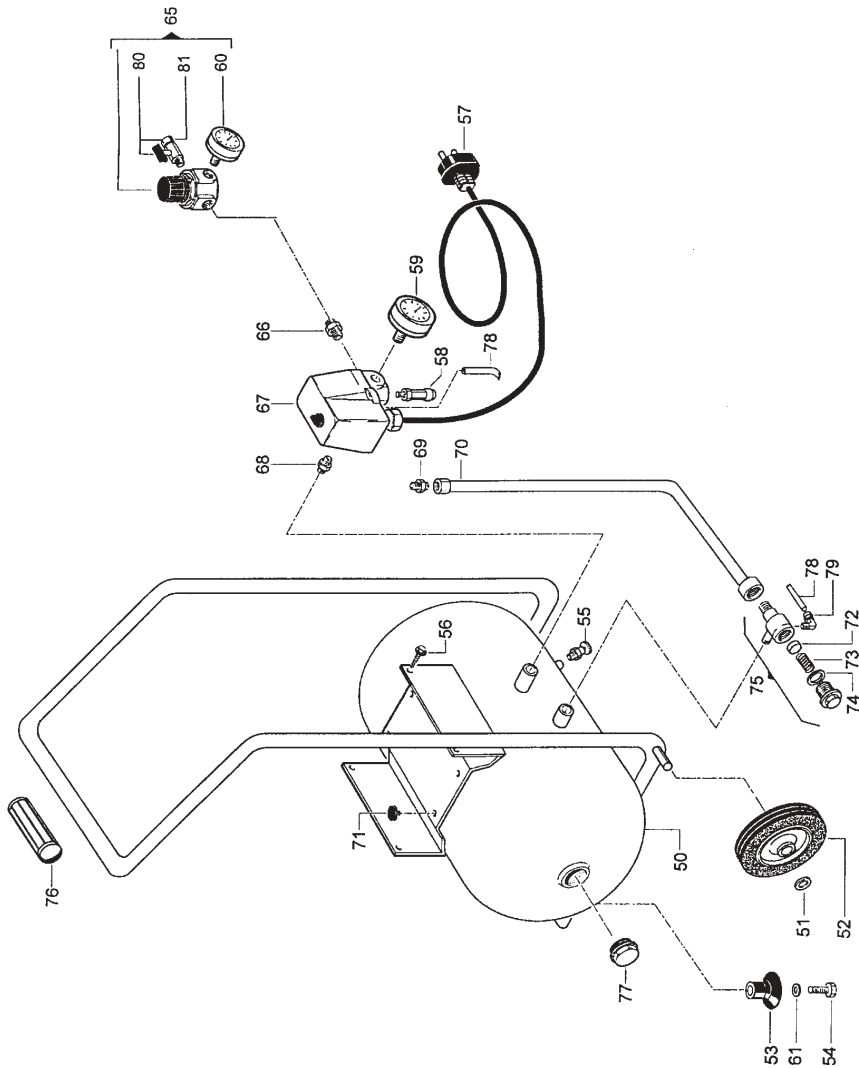

## ELECTRICAL CONNECTIONS

Connect the mains lead to a standard, 230 Volt (50Hz) electrical supply through an approved 13 amp BS 1363 plug, or a suitably fused isolator switch.

### WARNING! THIS APPLIANCE MUST BE EARTHED

**IMPORTANT:** The wires in the mains lead are coloured in accordance with the following code:

Green & Yellow	-	Earth
Blue	-	Neutral
Brown	-	Live

As the colours of the flexible lead of this appliance may not correspond with the coloured markings identifying terminals in your plug proceed as follows:

Connect GREEN & YELLOW cord to terminal marked with a letter "E" or Earth symbol "⏏" or coloured GREEN or GREEN & YELLOW.

Connect BROWN cord to terminal marked with a letter "L" or coloured RED.

Connect BLUE cord to terminal marked with a letter "N" or coloured BLACK.

If this appliance is fitted with a plug which is moulded onto the electric cable (i.e. non-rewireable) please note:

1. The plug must be thrown away if it is cut from the electric cable. There is a danger of electric shock if it is subsequently inserted into a socket outlet.
2. Never use the plug without the fuse cover fitted.
3. Should you wish to replace a detachable fuse carrier, ensure that the correct replacement is used (as indicated by marking or colour code).
4. Replacement fuse covers can be obtained from your local dealer or most electrical stockists.

### FUSE RATING

The fuse in the plug must be replaced with one of the same rating (**13 amps**) and this replacement must be approved to BS1362.

**We recommend that this machine is connected to the mains supply via a Residual Current Device (RCD)**

If in any doubt, DO NOT attempt any connections or repairs yourself. Consult a qualified electrician, your Clarke dealer, or CLARKE International Service Dep't on

020 8988 7400 or e-mail: [Service@clarkeinternational.com](mailto:Service@clarkeinternational.com)

## PREPARATION FOR USE

**NOTE:** All numbered items throughout this manual refer to the parts list item number on Page 14.

1. Remove the plastic travel plug from the oil filler hole, on the top of the crank case, and insert the dipstick (see Fig. 6 - p.8).
2. Check the oil level is at the correct level on the dipstick, as shown in Fig.1. Where necessary, top up with Clarke SAE40 Compressor Oil available from your Clarke dealer.

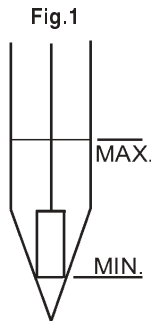

## OPERATION (Ref. Figs. 2 and 2A)

**NOTE:** if you intend using your compressor for spraying, read also the "Helpful Hints on Spraying" booklet - supplied with the machine.

1. Check that the mains voltage corresponds with that shown on the data sticker on the crankcase cover of the machine.
2. Ensure that the ON/OFF knob is in the 'OFF' (0) position, i.e. pushed DOWN, then plug in and switch on at the mains supply.
3. To start the compressor pull UP the ON/OFF knob to the 'ON' (I) position - the motor should start immediately.

*Note: Should the motor fail to start immediately, it is probable that the air receiver is already full of air. Check the tank pressure gauge (see fig. 2). If you release air, by opening air outlet tap, the motor will start automatically once the cut-in pressure is reached.*

4. Before connecting your airline to the compressor, allow it to run for 10 - 15 seconds, with the air outlet tap completely open to permit a good distribution of the lubricating oil.
5. Close the outlet tap then connect one end of suitable air hose to the compressor air outlet, and the other end to the equipment to be used.  
Set the outlet pressure by

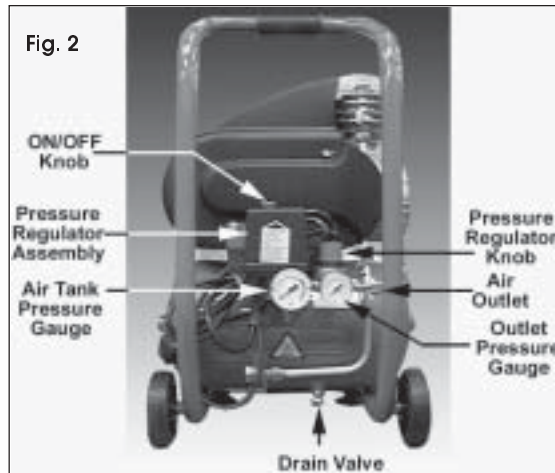

## SPECIFICATIONS

Rotational Speed .....	2850 rpm
Max. Pressure .....	10 bar
Air Displacement .....	200L/min (7 cfm approx.)
Electric Motor .....	1.5 hp (1.1 kW)
Receiver .....	9.5 Ltr
Compressor Oil .....	CLARKE SAE 40
Fuse Rating .....	13amps
Duty Cycle .....	S1 at max. 7 bar.
(i.e. Compressor may run continuously at 7 bar max.)	

Please note that the details and specifications contained herein, are correct at the time of going to print. However, CLARKE International reserve the right to change specifications at any time without prior notice. Always consult the machine's data plate

## ACCESSORIES

Your Clarke Pioneer 205 Air Compressor can be used in conjunction with a range of optional accessories for inflating tyres, air brushing, stapling, blowing and many other uses. For details contact your local accessory stockist.

A complete kit - **Model KIT 1000**, illustrated below, is available from your Clarke dealer which is ideal for almost all applications.

**Please quote part number 3110155**



A similar kit is available, without the spray gun - **Model KIT 600, Part No. 3110150**

The accessories are also available separately

Should you experience any difficulties obtaining accessories, please contact the Clarke sales department (telephone 01992 565300) for details of your nearest dealer.



## FAULT FINDING

PROBLEM	PROBABLE CAUSE	REMEDY
The compressor stops and will not start again.	Bad connections.  Blown fuse  Overload cutout switch has tripped.	Check the electrical connections. Clean and tighten as necessary.  Renew/Replace fuse  Switch off and wait 5 minutes before pressing the reset button.
The compressor does not reach the set pressure and overheats easily.	Compressor head gasket blown or valve broken.	Wait for compressor to cool down, disassemble the head and replace any broken components. Carefully clean all sealing surfaces before reassembling. If in doubt contact your nearest dealer.  NOTE: It is also possible that you are using more air than the compressor is capable of delivering.
Compressor does not start.	Air receiver charged (see also item 1)	Open drain cock to expel air. Compressor should start again when pressure reduces to approx 95 psi.
Air leaking from the pressure switch valve when the compressor is not running.	Faulty non-return valve.	First drain the receiver completely of air. Remove the valve end plug, carefully clean the valve seat and the gasket and reassemble. See Fig 8.
Air pressure from the regulator will not adjust.	The diaphragm within the regulator body is broken.	Replace Regulator
The compressor is very noisy and makes a metallic knocking sound.	Compressor damaged and needs overhaul.	Return the machine to your nearest service agent.

adjusting the Output Pressure Regulator. To do this, turn the Pressure Regulator Knob clockwise to increase pressure, anticlockwise to decrease.

Note: For most spraywork do not exceed 50 psi (unless following paint manufacturer's instructions).

For other airline equipment such as air tools, tyre gauges, staple guns, paraffin guns etc., it may be necessary to set the operating pressure at a higher (or lower) level.

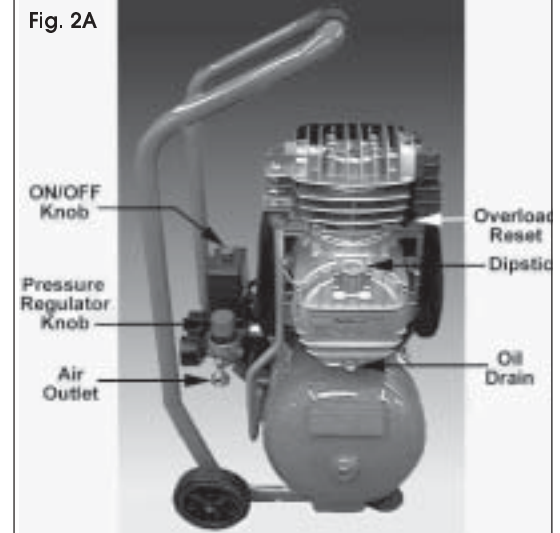

**IMPORTANT: Always refer to the accessory manufacturers recommendations for optimum operating pressures for their equipment.**

6. With operating pressure set, re-open the air outlet tap.
7. The Pressure Switch, located within the plastic cover beneath the ON/OFF knob, should not require adjustment. This is an automatic device and has been pre-set at the factory to stop the motor when pressure in the receiver reaches its maximum, and to start it again when the pressure in the receiver falls to the minimum preset value. This operation is completely automatic and does not affect the spraying process in any way. However, should problems develop with the cut-in, cut out settings, please consult your Clarke dealer, or the Clarke Service Dep't.

**NOTE:**

- a. If the machine pumps continuously without cutting out then the compressor is too small for the application/tool being used, and damage may result. Consult your Clarke dealer.
- b. The motor is protected by a Thermal Overload so that if the motor overheats for any reason - the thermal overload will trip, stopping the motor. To restart, allow a period for the motor to cool down, before pressing the Reset Button, illustrated in fig 2A and 3.
- c. **DO NOT exceed the Duty Cycle for the machine (see Specifications).**

Fig. 3

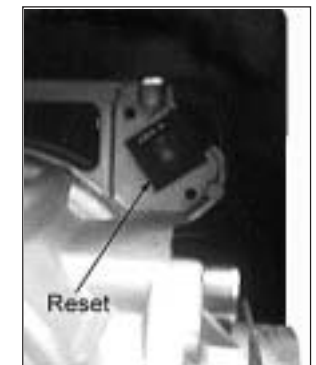

## SHUTTING DOWN THE COMPRESSOR

1. To shut off the compressor, simply press DOWN on the ON/OFF knob (See Fig. 2) . Always use this knob to shut down the compressor. NEVER USE THE MAINS SWITCH TO STOP MOTOR.
2. Close the air outlet tap and trigger the equipment (spraygun, air tool etc.) to release air from the air hose before disconnecting the hose from the machine.
3. Before transporting your compressor or when leaving overnight, expel all air from the receiver by opening the drain valve (55).

## MAINTENANCE

### A. DAILY

1. Drain any condensate that may have accumulated in the receiver daily by unscrewing the drain valve underneath the air receiver (figs. 2 and 5).
2. Check the oil level before you start and top up if necessary - (use Clarke SAE 40 compressor oil).

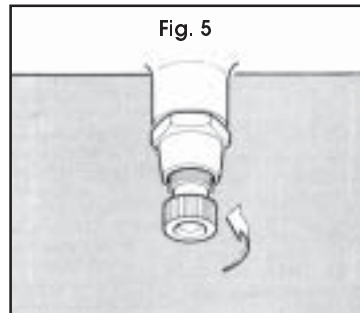

### B. PERIODICALLY

1. After the first 5 hours of running the compressor, check the cylinder head bolts and motor housing screws and re-tighten if any have worked loose.
2. After the first 100 hours use replace the oil completely using Clarke SAE 40 compressor oil. Thereafter replace the oil completely after every 500 hours of operation or every 6 months. To empty the oil from the machine remove the drain plug from the crankcase cover (see figs. 2A and 6).
3. Every 50 hours (more frequently if used in a dusty environment), clean the air intake filter, by carefully prising off the plastic filter from the air inlet, opening the bottom flap, and withdrawing the sponge element (see Fig 7).

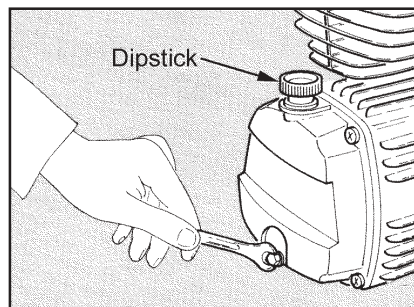

Clean the sponge and the inner housing. If necessary, the sponge filter may be gently washed in warm soapy water, rinsed and allowed to dry thoroughly

before refitting. Ensure that the outer filter cover is then pushed back on to the air inlet.

If any part of the filter is damaged then you should obtain a replacement.

4. Every 500 hours of operation or every 6 months
  - clean all the external parts of the compressor.

(This cleaning makes the cooling process more efficient and prolongs the life of the machine).

- Check and clean the inlet and outlet valves (consult your Clarke dealer).
  - Examine the non-return valve and replace the gasket if necessary (fig. 8)
5. In the event of an air leak follow the procedure below:
    - Load compressor to maximum pressure.
    - Unplug the compressor.
    - With a brush and soapy water wet all 'screwed' connections.
    - Any leaks will show through the formation of air bubbles.



Fig. 7

Parts List item No. 59

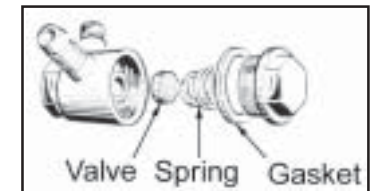

Fig. 8

### WARNING

**NEVER UNSCREW A CONNECTION WHILST THE AIR RECEIVER IS UNDER PRESSURE. ALWAYS MAKE CERTAIN THAT THE TANK HAS FIRST BEEN EMPTIED.**